



**Apollo**  
**Sunguard**  
systems, Inc.

[www.simexco.com](http://www.simexco.com)  
1.888.441.2040

# Distributeur

# Page des matières

Adresse : 1709 Montée Ste-Julie, Ste-Julie Qc, J3N 1Y2

Sans-frais : 1-888-441-2040

Téléphone : 450-922-2040

Fax : 450-922-7343

Site web : [www.simexco.com](http://www.simexco.com)



Information	2	Information
Page des matières	2	Information
Simexco	4	Information
Rectangles	5	Général
Carrés	6	Général
Triangles	7	Général
Hexagonals	8	Général
Octogonals	8	Général
Information	10	Information
Structure	11	Structure
Tour de jeux carrée	12-13	Information
Tour de jeux hexagonal	14	Information
3 rangées couverts	16	Gradin
5 rangées couverts	17	Gradin
10 rangées couverts	18	Gradin
T-styles	19	Bancs et embarcations
Panneaux latéraux	20	Module cantilevers
x-10 : rangée simple	22	Module cantilevers
x-10 : rangée double	23	Module cantilevers
Parc ombragé : simple	24	Module cantilevers
Parc ombragé : double	25	Module cantilevers
Ombrage	26	Module cantilevers
Super contemporain	27	Module cantilevers
Systèmes de chauffages	28	Accessoires
Systèmes d'éclairages	28	Accessoires
Systèmes de ventilateurs	28	Accessoires
Coussin pour poteaux	28	Accessoires
Toile de remplacement	28	Accessoires
Montage en surface	28	Accessoires
Logos	28	Accessoires
Information	30	Information
Couleurs d'armature	31	Armature

### Structure de grande qualité

Toute la structure est en acier galvanisé avec une triple couche de protection extrêmement résistante à la corrosion.

### Câble de tension

Toron d'acier galvanisé tressé (3 mèches) pour une protection durable à la corrosion.

### Toile de qualité supérieure

La toile Sunguard est reconnue pour sa longévité et ses couleurs vivantes. Elle est composée d'un tricot de polyéthylène haute densité avec traitement contre les ultraviolets qui lui assure une stabilité à la couleur. La toile ne se desséchera pas et gardera toujours sa forme.

### Spécifications techniques

Force du tricot : 260 KPA

Résistance au déchirement : 100 KG (déformation); 210 KG (trame)

Résistance aux flammes : Test # E-84 (test d'inflammabilité) selon le NFPA-701 Matériel Classe 1

### Garanties

Structure garantie 20 ans.

Toile garantie 10 ans.

### Protection contre les ultraviolets.

Sunguard est la seule compagnie à avoir sa propre toile testée par un laboratoire indépendant afin de vérifier et certifier que son tricot bloque les rayons jusqu'à 97%.

### Résistance aux vents

La toile résiste aux vents jusqu'à 178 km/h. et est conforme aux exigences les plus sévères du Code du bâtiment.

Modèle	Dimension <sup>1</sup>	Aire <sup>2</sup>	Hauteur maximale <sup>3</sup>	Finition	Poids <sup>4</sup>
R1012G	10'x12'X8'	120	9.6'	Galvanisé	312
R1012P	10'x12'X8'	120	9.6'	Polyester	312
R1016G	10'x16'X8'	160	9.6'	Galvanisé	332
R1016P	10'x16'X8'	160	9.6'	Polyester	332
R1020G	10'x20'X8'	200	10'	Galvanisé	355
R1020P	10'x20'X8'	200	10'	Polyester	355
R1024G	10'x24'X8'	240	10.3'	Galvanisé	380
R1024P	10'x24'X8'	240	10.3'	Polyester	380
R1030G	10'x30'X8'	300	10.3'	Galvanisé	420
R1030P	10'x30'X8'	300	10.3'	Polyester	420

R1810G	18'x10'X8'	180	10.0'	Galvanisé	345
R1810P	18'x10'X8'	180	10.0'	Polyester	345
R1816G	18'x16'X8'	288	10.3'	Galvanisé	433
R1816P	18'x16'X8'	288	10.3'	Polyester	433
R1820G	18'x20'X8'	360	10.5'	Galvanisé	470
R1820P	18'x20'X8'	360	10.5'	Polyester	470
R1824G	18'x24'X8'	432	10.5'	Galvanisé	495
R1824P	18'x24'X8'	432	10.5'	Polyester	495
R1826G	18'x26'X8'	468	10.5'	Galvanisé	510
R1826P	18'x26'X8'	468	10.5'	Polyester	510
R1830P	18'x30'X8'	540	11.3'	Galcanisé	615
R1830G	18'x30'X8'	540	11.3'	Polyester	615
R1832P	18'x32'X8'	576	11.3'	Polyester	630
R1840P	18'x40'X8'	720	11.3'	Polyester	730

R2012G	20'x12'X8'	240	10.3'	Galvanisé	375
R2012P	20'x12'X8'	240	10.3'	Polyester	375
R2015G	20'x15'X8'	300	10.3'	Galvanisé	396
R2015P	20'x15'X8'	300	10.3'	Polyester	396
R2016G	20'x16'X8'	320	10.3'	Galvanisé	450
R2016P	20'x16'X8'	320	10.3'	Polyester	450
R2022G	20'x22'X8'	440	10.9'	Galvanisé	505
R2022P	20'x22'X8'	440	10.9'	Polyester	505
R2024G	20'x24'X8'	480	10.9'	Galvanisé	520
R2024P	20'x24'X8'	480	10.9'	Polyester	520
R2028G	20'x28'X8'	560	10.9'	Galvanisé	602
R2028P	20'x28'X8'	560	10.9'	Polyester	602
R2030G	20'x30'X8'	600	10.9'	Galvanisé	620
R2030P	20'x30'X8'	600	10.9'	Polyester	620
R2040G	20'x40'X8'	800	11.4'	Galvanisé	750

R3032P	30'x32'X8'	960	12.3'	Polyester	775
R3034P	30'x34'X8'	1020	12.3'	Polyester	810
R3036P	30'x36'X8'	1080	12.3'	Polyester	830
R3040P	30'x40'X8'	1200	12.3'	Polyester	870



Florida House  
Sarasota, FL



<sup>1</sup>Longueur x largeur x hauteur (poteaux).

<sup>2</sup>Pieds Carrés.

<sup>3</sup>Hauteur maximale pour poteaux de 8'.

<sup>4</sup>Poids (lb) approximatif des marchandises expédiées.



Modèle	Dimension <sup>1</sup>	Aire <sup>2</sup>	Hauteur Maximale <sup>3</sup>	Finition	Poids <sup>4</sup>
S1010G	10'x10'x8'	100	9.6'	Galvanisé	310
S1010P	10'x10'x8'	100	9.6'	Polyester	310

S1212G	12'x12'x8'	144	10'	Galvanisé	325
S1212P	12'x12'x8'	144	10'	Polyester	325

S1515G	15'x15'x8'	225	10.3'	Galvanisé	360
S1515P	15'x15'x8'	225	10.3'	Polyester	360

S1616G	16'x16'x8'	256	10.3'	Galvanisé	425
S1616P	16'x16'x8'	256	10.3'	Polyester	425

S1818G	18'x18'x8'	324	10.5'	Galvanisé	460
S1818P	18'x18'x8'	324	10.5'	Polyester	460

S2020G	20'x20'x8'	400	10.9'	Galvanisé	490
S2020P	20'x20'x8'	400	10.9'	Polyester	490

S2222G	22'x22'x8'	484	11.3'	Galvanisé	590
S2222P	22'x22'x8'	484	11.3'	Polyester	590

S2424P	24'x24'x8'	576	11.4'	Polyester	620
S2525P	25'x25'x8'	625	11.4'	Polyester	640
S2626P	26'x26'x8'	676	11.7'	Polyester	660
S2828P	28'x28'x8'	784	12.0'	Polyester	700

S3030P	30'x30'x8'	900	12.3'	Polyester	770
S4040P	40'x40'x8'	1600	13.8'	Polyester	1,530



Governor's Mansion  
Austin, TX



Forty Carrots Pre-school  
Sarasota, FL



E.A. Lyons Elementary School  
Houston, TX

<sup>1</sup>Longueur x largeur x hauteur (poteaux).

<sup>2</sup>Pieds Carrés

<sup>3</sup>Hauteur maximale pour poteaux de 8'.

<sup>4</sup>Poids (lb) approximatif des marchandises expédiées.

Modèle	Dimension <sup>1</sup>	Aire <sup>2</sup>	Hauteur Maximale <sup>3</sup>	Finition	Poids <sup>4</sup>
T16P	16'x8'	110	10.6'	Polyester	295
T18P	18'x8'	140	10.4'	Polyester	320
T20P	20'x8'	173	10.6'	Polyester	380
T22P	22'x8'	209	11.0'	Polyester	410
T23P	23'x8'	229	11.0'	Polyester	450
T24P	24'x8'	249	11.2'	Polyester	490
T25	25'x8'	270	11.3'	Polyester	510
T26P	26'x8'	292	11.4'	Polyester	525
T28P	28'x8'	339	11.7'	Polyester	575
T30P	30'x8'	389	12.0'	Polyester	650

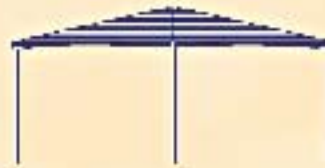

triangles



**Child Development Center  
Federal Building  
Honolulu, HI**

<sup>1</sup>Longueur x largeur x hauteur (poteaux)

<sup>2</sup>Pieds Carrés

<sup>3</sup>Hauteur maximale pour poteaux de 8'.

<sup>4</sup>Poids (lb) approximatif des marchandises expédiées.



**Cove Creek Park  
Cove Creek, VA**



**Fallsmeade Swim Club  
Potomoc, MD**

# hexagones



Modèle	Dimension <sup>1</sup>	Aire <sup>2</sup>	Hauteur Maximale <sup>3</sup>	Finition	Poids <sup>4</sup>
H24P	24'	374	10.7'	Polyestère	710
H26P	26'	439	11.0'	Polyestère	770

H30P	30'	585	11.4'	Polyester	880
H36P	36'	842	12.1'	Polyester	1,100

H40P'	40'	1039	12.5'	Polyester	1,240
H45P	45'	1316	13.1'	Polyester	1,430

<sup>1</sup>Diamètre

<sup>2</sup>Pieds Carrés

<sup>3</sup>Hauteur maximale pour poteaux de 8'.

<sup>4</sup>Poids (lb) approximatif des marchandises expédiées



Scott Air Force Base  
Illinois

# octogonaux



Modèle	Dimension <sup>1</sup>	Aire <sup>2</sup>	Hauteur Maximale <sup>3</sup>	Finition	Poids <sup>4</sup>
O40P	40'	1132	13.9'	Polyester	1,510
O45P	45'	1433	14.6'	Polyester	1,815

<sup>1</sup>Diamètre

<sup>2</sup>Pieds Carrés

<sup>3</sup>Hauteur maximale pour poteaux de 8'.

<sup>4</sup>Poids (lb) approximatif des marchandises expédiées.



Cove Creek Park  
Faber, VA



Trident Refit Facility  
Kings Bay Naval Submarine Station  
Jacksonville, FL



GT Bray Baseball Park  
Bradenton, FL



Norfolk Naval Shipyard  
Norfolk, VA



Four Seasons  
Andrews Air Force Base  
Washington, D.C.



Farmers Market  
Sarasota, FL





Modèle	Dimension	Hauteur maximale <sup>1</sup>	Aire	Finition	Poids <sup>2</sup>
US12P	12'x12'	10'	144'	Polyester	300
US15P	15'x15'	10'-4"	225'	Polyester	325
US16P	16'x16'	10'-7"	256'	Polyester	400

<sup>1</sup> La hauteur la plus basse est de 8'.

<sup>2</sup>Poids (lb) approximatif des marchandises expédiées.

# BreezeBrellas

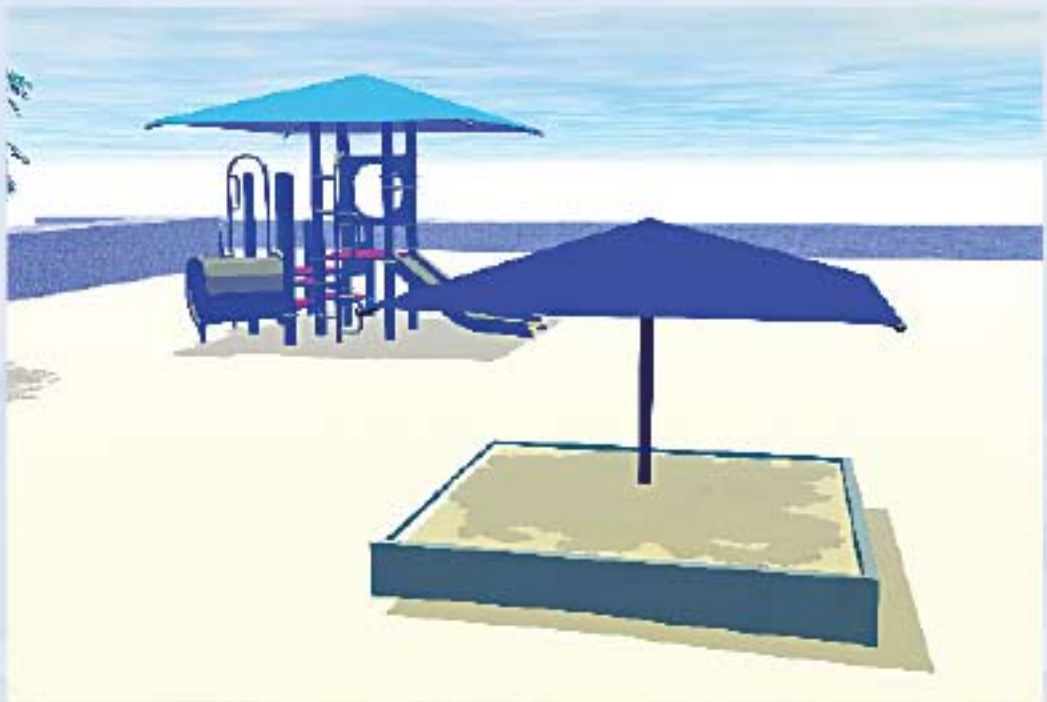
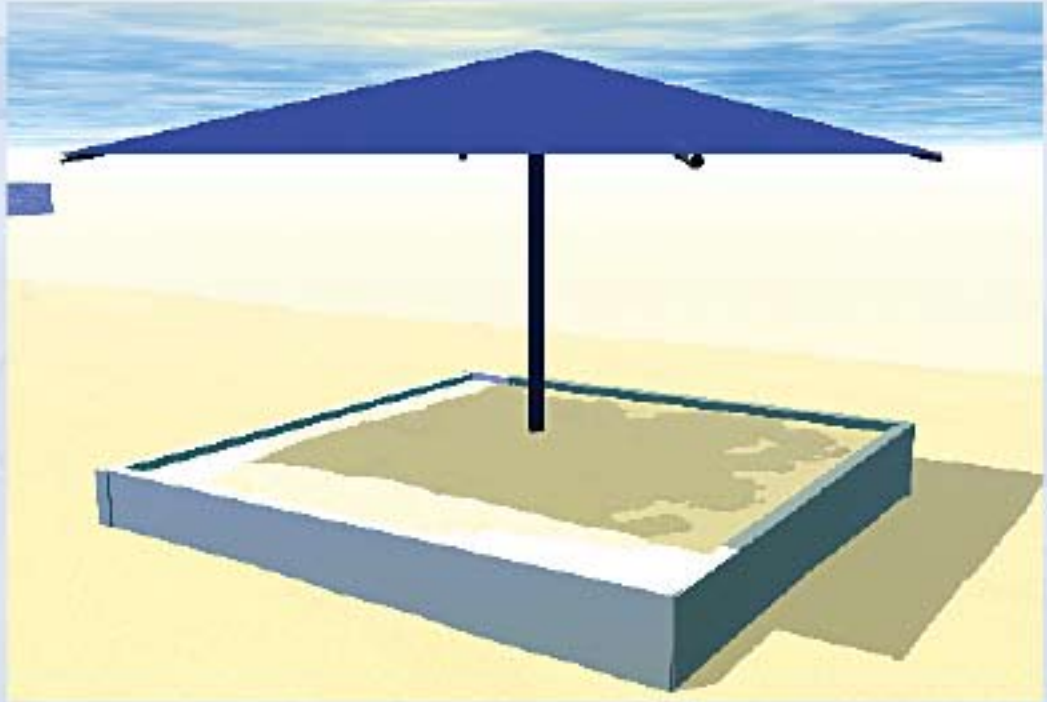

Modèle	Diamètre	Aire <sup>1</sup>	Hauteur Maximale	Finition	Poids <sup>2</sup>
U17P	17'	289'	10.4'	Polyester	400
U18P	18'	324'	10.9'	Polyester	400
U19P	19'	361'	10.9'	Polyester	400
U20P	20'	400'	10.9'	Polyester	400

<sup>1</sup>Dimension approximative au pied carré.

<sup>2</sup>Poids (lb) approximatif des marchandises expédiées.



breezebrellas hexagonal

# BreezeBrellas



Greenwood Recreation Center  
Clearwater, FL



South County Regional Water Park  
Port Charlotte, FL

German School  
Potomoc, MD





Modèle	Dimension <sup>1</sup>	Finition	Poids <sup>2</sup>
PT1515P	15' x 15' x 8'	Polyester	360
PT1818P	18' x 18' x 8'	Polyester	400
PT2020P	20' x 20' x 8'	Polyester	490
PT2222P	22' x 22' x 8'	Polyester	600
PT2525P	25' x 25' x 8'	Polyester	640

# Play Towers

<sup>1</sup>Toutes les dimensions indiquées sont longueur x largeur x hauteur.

<sup>2</sup>Poids (lb) approximatif des marchandises expédiées; sujet au changement.



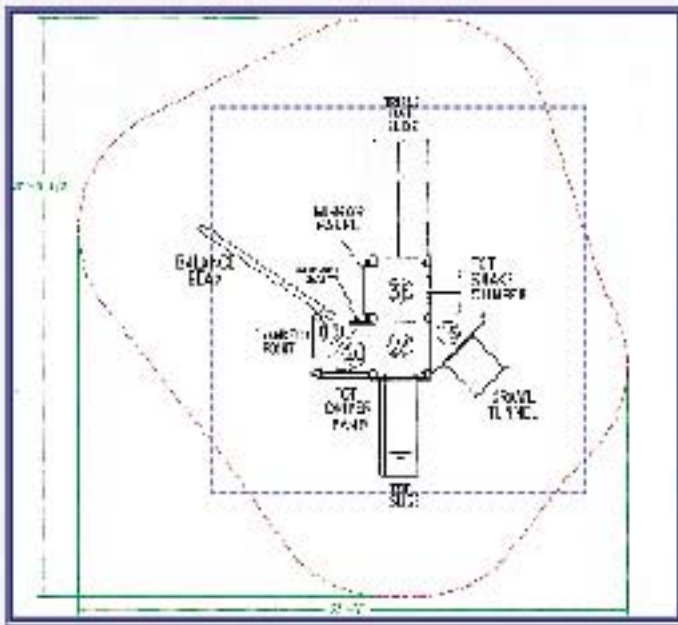

play towers

# Play Towers





Modèle	Diamètre <sup>1</sup>	Finition	Poids <sup>2</sup>
PBH12P	12'	Polyester	360
PBH14P	14'	Polyester	360
PBH16P	16'	Polyester	400
PBH18P	18'	Polyester	400
PBH20P	20'	Polyester	490

# Play Towers

<sup>1</sup>Toutes les dimensions indiquées sont longueur x largeur x hauteur.

<sup>2</sup>Poids (lb) approximatif des marchandises expédiées; sujet au changement.





Longwood Park  
Sarasota, FL



Annapolis Naval Station CDC  
Annapolis, MD



Gaithersburg Water Park  
Gaithersburg, MD

# 3 gradins couverts



Dimension du gradin		Couverture recommandée		
Longueur	Capacités	Modèle	Dimension <sup>1</sup>	Poids <sup>2</sup>
15'	30	B1810G	18x10'x8'	345
21'	42	B2410G	24'x10'x8'	378
27'	54	B3010G	30'x10'x8'	414

<sup>1</sup>Toutes les dimensions indiquées sont longueur x largeur x hauteur (poteaux).  
<sup>2</sup>Poids (lb) approximatif des marchandises expédiées.  
<sup>3</sup>Taille maximale pour trois unités de rangées: 9'-5".



Cal Ripken Little League Complex  
Sarasota, FL

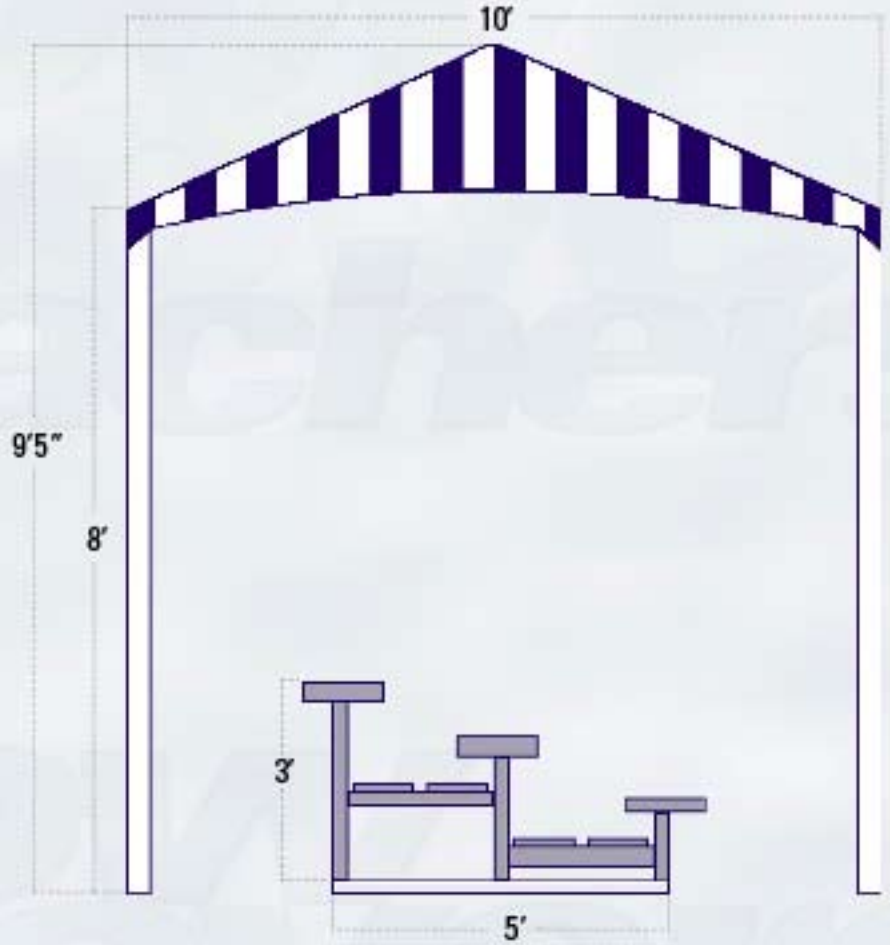

## Dimension du gradin

Longueur	Capacités
15'	50
21'	70
27'	90

## Couverture recommandée

Modèle	Dimension <sup>1</sup>	Poids <sup>2</sup>
B1812G	18'x12'x9'	355
B2412G	24'x12'x9'	410
B3012G	30'x12'x9'	500



5 rangées couvertes

<sup>1</sup>Toutes les dimensions indiquées sont longueur x largeur x hauteur (poteaux).

<sup>2</sup>Poids (lb) approximatif des marchandises expédiées.

<sup>3</sup>Taille maximale pour trois unités de rangées: 11'.

Braden River Lit.  
Bradenton, FL

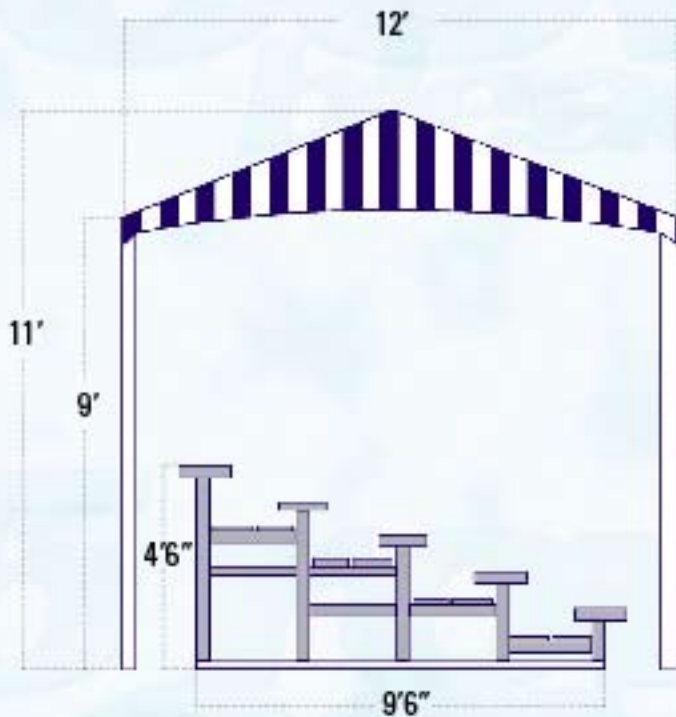

Cal Ripken Little League Complex  
Sarasota, FL





Dimension du gradin

Couverture recommandée

Longueur	Capacités	Modèle	Dimension <sup>1</sup>	Poids <sup>2</sup>
15'	100	B1822G	18'x22'x12'	480
21'	140	B2422G	24'x22'x12'	528
27'	180	B3022G	30'x22'x12'	651

<sup>1</sup>Toutes les dimensions indiquées sont longueur x largeur x hauteur (poteaux).

<sup>2</sup>Poids (lb) approximatif des marchandises expédiées.

<sup>3</sup>Taille maximale pour trois unités de rangées : 16'



Sarasota Redskins Football Complex  
Sarasota, FL



Cal Ripken Little League Complex  
Sarasota, FL

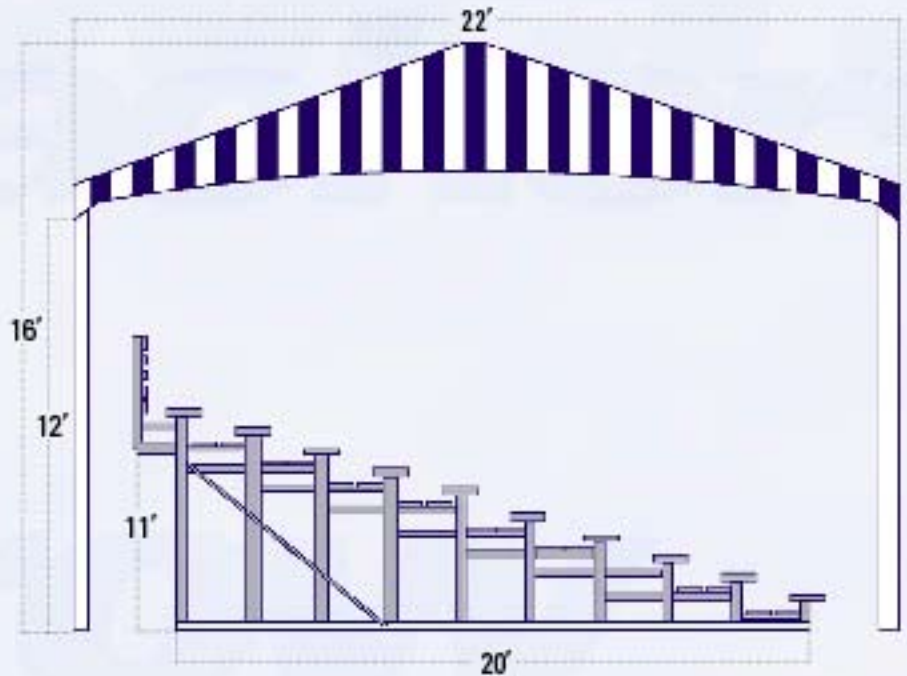

Protéger les joueurs avec notre toile solaire conçue expressément pour ce besoin. Notre système à deux poteaux procure la protection adéquate tout en laissant la vue libre aux joueurs et aux partisans.

t-styles

Modèle	Dimension <sup>1</sup>	Hauteur maximale	Finition	Poids <sup>2</sup>
D1012G	10'x12'x8'	9.8'	Galvanisé	232
D1012P	10'x12'x8'	9.8'	Polyester	232
D1016G	10'x16'x8'	9.8'	Galvanisé	260
D1016P	10'x16'x8'	9.8'	Polyester	260
D1018G	10'x18'x8'	10.3'	Galvanisé	275
D1018P	10'x18'x8'	10.3'	Polyester	275
D1020G	10'x20'x8'	10.3'	Galvanisé	295
D1020P	10'x20'x8'	10.3'	Polyester	295

<sup>1</sup>Toutes les dimensions indiquées sont longueur x largeur x hauteur.

<sup>2</sup>Poids (lb) approximatif des marchandises expédiées.

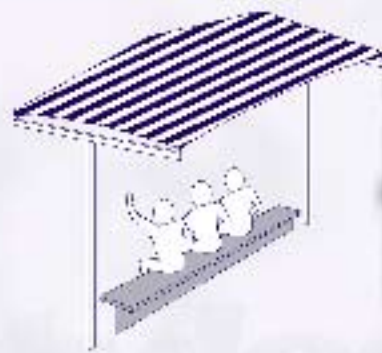

Automation Car Wash  
Houston, TX



Ashton Elementary School  
Sarasota, FL



Fruitville Public Library Butterfly Garden  
Sarasota, FL



Gaithersburg Water Park  
Custom T-Style  
Gaithersburg, MD



### Description

Protéger vos partisans avec nos toiles solaires conçues expressément pour les grilles de protection des fausses balles. Les panneaux latéraux peuvent être suspendu entre n'importe quel poteau. Les panneaux latéraux sont munis de câbles d'acier galvanisé et des dispositifs d'assemblage.



St. Anne's School  
Charlottesville, VA

Grove City Parks & Recreation  
Grove City, OH





Naples Preschool Academy  
Naples, FL



Blue Dolphin Car Wash  
Bradenton, FL

Photo Tech World Headquarters  
Sarasota, FL



Lexington Middle School  
Ft Myers, FL





Longueur de 18' à 20'

Projections de 16' à 20'

Type	Modèle	Longueur	Projection	Hauteur		Finition	Poids
				Entrée	Maximale		
Principal	SX1820SMP	18' à 20'	16' à 20'	8'	12'-1"	Polyester	1,066
Ajout	SX1820SAP	18' à 20'	16' à 20'	8'	12'-1"	Polyester	670



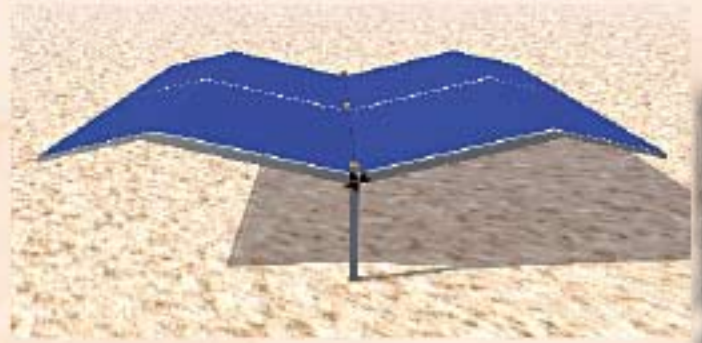
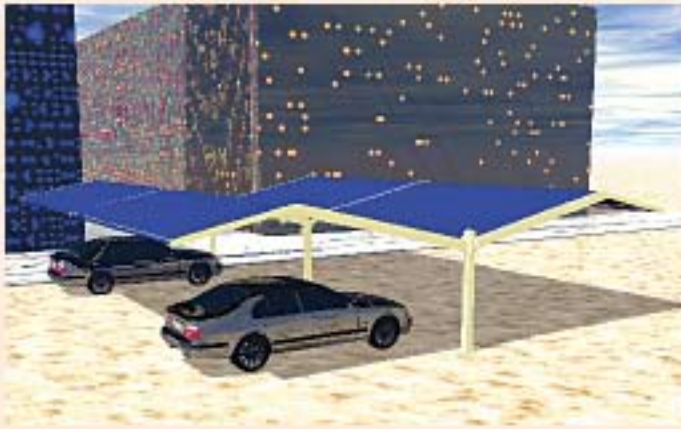

module cantilevers

Longueurs de 18' à 20'

Projections de 32' à 40'

Type	Modèle	Longueur	Projection	Hauteur		Finition	Poids
				Entrée	Maximale		
Principal	SX1820DMP	18' à 20'	32' à 40'	8'	12'-1"	Polyester	1,723
Ajout	SX1820DAP	18' à 20'	32' à 40'	8'	12'-1"	Polyester	1,130

X-10



rangée double

rangée simple



East Cobb Baseball  
Cobb County, GA

rangée simple

Longueurs de 18' à 20'

Projections de 17' à 20'

Type <sup>1</sup>	Modèle	Longueur	Projection	Hauteur		Finition	Poids <sup>2</sup>
				Entrée	Maximale		
Principal	SP1820SMP	18' à 20'	17' à 20'	8'	11.6'	Polyester	1,066
Ajout	SP1820SAP	18' à 20'	17' à 20'	8'	11.6'	Polyester	670

Longueurs de 21' à 23'

Projections de 17' à 20'

Type <sup>1</sup>	Modèle	Longueur	Projection	Hauteur		Finition	Poids <sup>2</sup>
				Entrée	Maximale		
Principal	SP2123SMP	21' à 23'	17' à 20'	8'	11.6'	Polyester	1,066
Ajout	SP2123SAP	21' à 23'	17' à 20'	8'	11.6'	Polyester	670

Woodland Baptist Church  
Bradenton, FL



<sup>1</sup>Type de structure.  
<sup>2</sup>Poids (lb) approximatif des marchandises expédiées.

module cantilevers

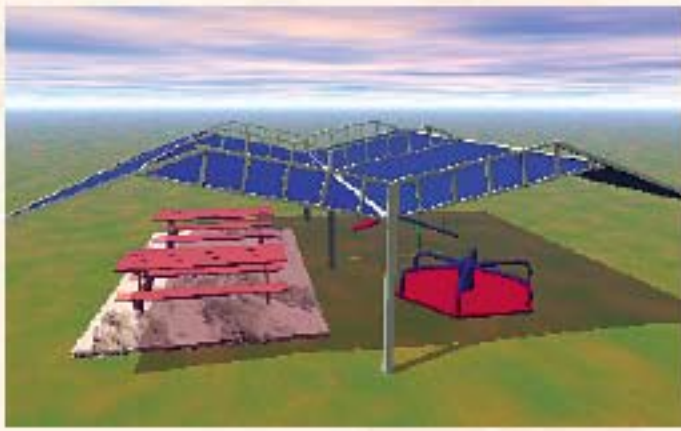

Parc / Équipement de jeux  
Concept (rendu)



module cantilevers

parc ombragé  
rangée double

Longueur de 18' à 20'

Projection de 34' à 40'

Type <sup>1</sup>	Modèle	Longueur	Projection	Hauteur		Finition	Poids
				Entrée	Maximale		
Principal	SP1820DMP	18' à 20'	34' à 40'	8'	11.6'	Polyester	1,723
Ajout	SP1820DAP	18' à 20'	34' à 40'	8'	11.6'	Polyester	1,130

Longueur de 21' à 23'

Projection de 34' à 40'

Type <sup>1</sup>	Modèle	Longueur	Projection	Hauteur		Finition	Poids <sup>2</sup>
				Entrée	Maximale		
Principal	SP2120DMP	18' à 20'	34' à 40'	8'	11.6'	Polyester	1,723
Ajout	SP2120DAP	18' à 20'	34' à 40'	8'	11.6'	Polyester	1,130

Concept (rendu)  
vue de dessus

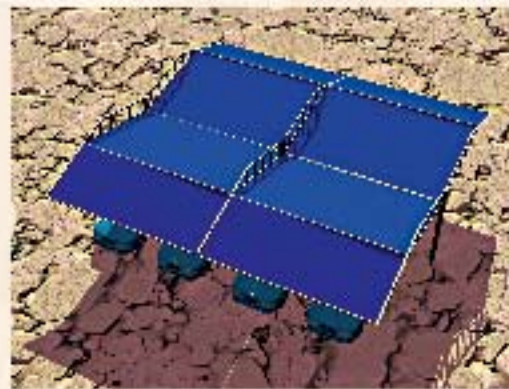

<sup>1</sup>Type de structure.

<sup>2</sup>Poids (lb) approximatif des marchandises expédiées.



ombrage



North Collier Hospital  
Ft Myers, FL

Longueurs de 18' à 20'

Projections de 16' à 20'

Type <sup>1</sup>	Modèle	Longueur	Projection	Hauteur		Aire <sup>2</sup>	Finition	Poids <sup>3</sup>
				Entrée	Maximale			
Principal	SW1820MP	18' à 20'	16' à 20'	8'	10.3'	288' à 463'	Polyester	675
Ajout	SW1820AP	18' à 20'	16' à 20'	8'	10.3'	288' à 463'	Polyester	465

module cantilevers

Longueurs de 18' à 20'

Projections de 16' à 20'

Type <sup>1</sup>	Modèle	Longueur	Projection	Hauteur		Aire <sup>2</sup>	Finition	Poids <sup>3</sup>
				Entrée	Maximale			
Principal	SW2123SMP	21' à 23'	16' à 20'	8'	10.3'	288' à 463'	Polyester	1,066
Ajout	SW1820SAP	21' à 23'	16' à 20'	8'	10.3'	288' à 463'	Polyester	670



North Collier Hospital  
Ft Myers, FL

<sup>1</sup>Type de structure.  
<sup>2</sup>Aire (pieds carrés).  
<sup>3</sup>Poids (lb) approximatif des marchandises expédiées.

Type <sup>1</sup>	Modèle	Dimension <sup>2</sup>	Hauteur	Finition	Poids <sup>3</sup>
Principal	SCC2020MP	20'x20'x8'	11'-8.5"	Polyester	925
Ajout	SCC2020AP	20'x20'x8'	11'-8.5"	Polyester	925

<sup>1</sup>Type de structure.

<sup>2</sup>Toutes les dimensions indiquées sont longueur x largeur x hauteur.

<sup>3</sup>Poids (lb) approximatif des marchandises expédiées.

Montage en surface seulement.

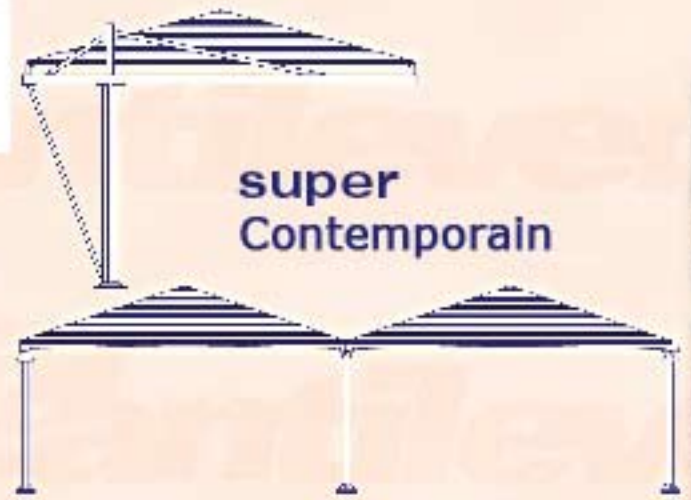

module cantilevers

super contemporain



Pohick Golf Course  
Virginia



Grand Lakes Resort  
Ritz-Marriott  
Orlando, FL

## Toile de remplacement

accessoires



Toile de remplacement



Toile de remplacement  
avec câble et attaches

## Poteaux



Coussin protecteur pour poteaux

## Montage en surface



## Options additionnelles

- Logos
- Systèmes de ventilateurs
- Systèmes de chauffages
- Systèmes d'éclairages



Ashton Elementary School  
Sarasota, FL



Lackland Air Force Base  
Systèmes de ventilateurs  
San Antonio, TX

## Description

L'ensemble comprend : tige de soutien, attache de table/chaise et sac de rangement. Diamètre : 52 po.

L'abri solaire portatif ( ASP) a été conçu comme abri soleil et comme parapluie à la fois. La toile, perméable à l'air, est fabriquée en polyéthylène haute densité. Il s'agit de la même toile que celle des abris. Sous l'ASP, température est diminuée de près de 15 degrés Celsius et les rayons UV sont bloqués à 93%. La toile de l'ASP résiste à des vents de plus de 60 km/h.

**psd**  
PERSONAL  
SHADE  
DEVICE



Table de pique-nique



Jardinage

Ponton et bateau



La plage



Bord de piscine et terrasse



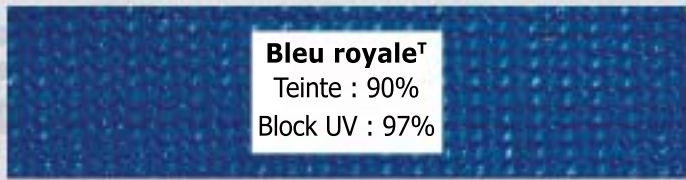

**Bleu royale<sup>T</sup>**  
Teinte : 90%  
Block UV : 97%



**Bleu royale<sup>T</sup>**  
Teinte : 95%  
Block UV : 96%

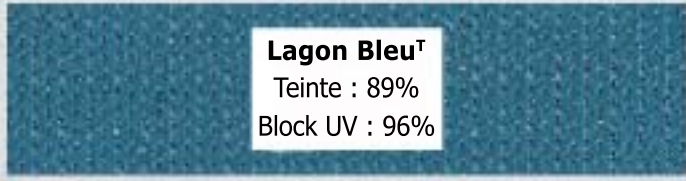

**Lagon Bleu<sup>T</sup>**  
Teinte : 89%  
Block UV : 96%

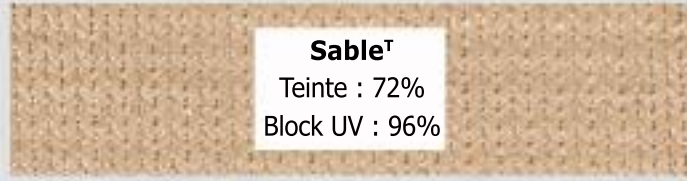

**Sable<sup>T</sup>**  
Teinte : 72%  
Block UV : 96%

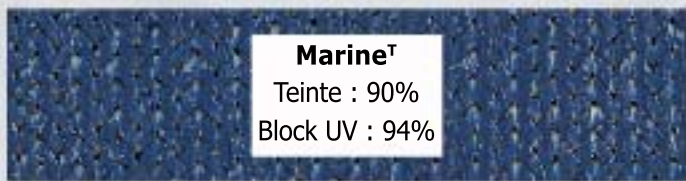

**Marine<sup>T</sup>**  
Teinte : 90%  
Block UV : 94%



**Acacia<sup>T</sup>**  
Teinte : 77%  
Block UV : 95%

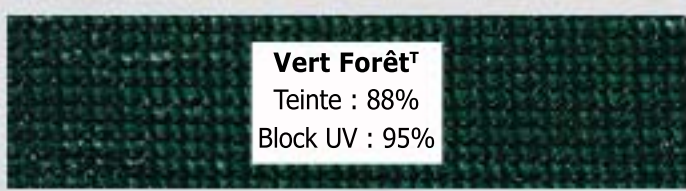

**Vert Forêt<sup>T</sup>**  
Teinte : 88%  
Block UV : 95%

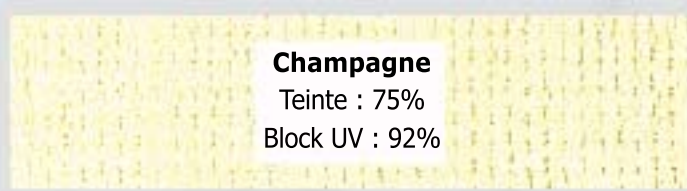

**Champagne**  
Teinte : 75%  
Block UV : 92%

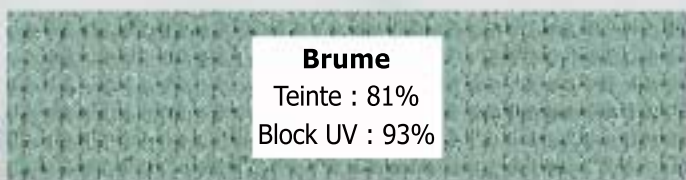

**Brume**  
Teinte : 81%  
Block UV : 93%

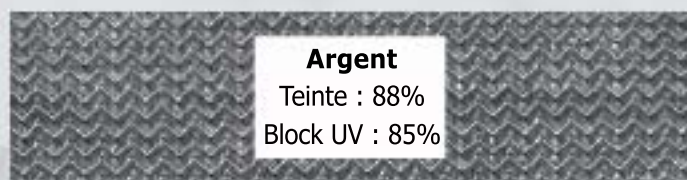

**Argent**  
Teinte : 88%  
Block UV : 85%

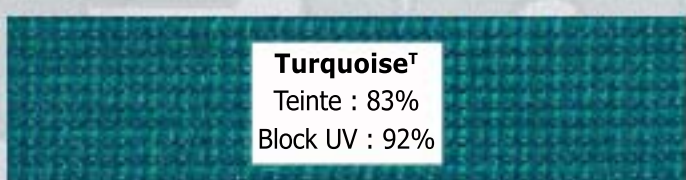

**Turquoise<sup>T</sup>**  
Teinte : 83%  
Block UV : 92%

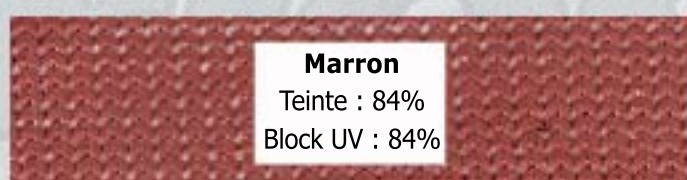

**Marron**  
Teinte : 84%  
Block UV : 84%

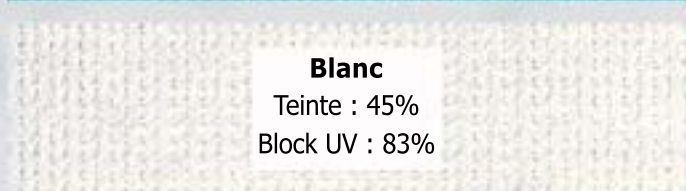

**Blanc**  
Teinte : 45%  
Block UV : 83%



**Jaune et bleu**  
Teinte : 60%  
Block UV : 80%

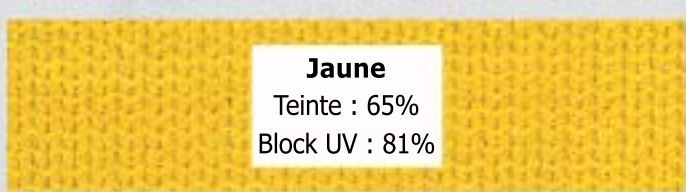

**Jaune**  
Teinte : 65%  
Block UV : 81%

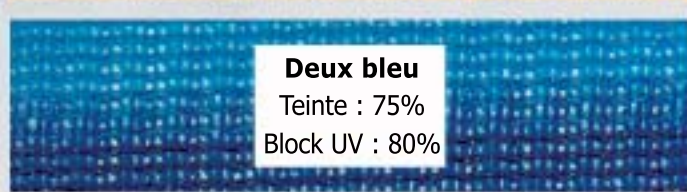

**Deux bleu**  
Teinte : 75%  
Block UV : 80%



**Bleu/blanc**  
Teinte : 60%  
Block UV : 81%

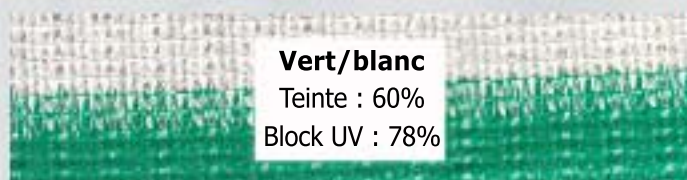

**Vert/blanc**  
Teinte : 60%  
Block UV : 78%

\* En raison des limites d'impression, les couleurs peuvent changer légèrement des couleurs réelles.



Noir

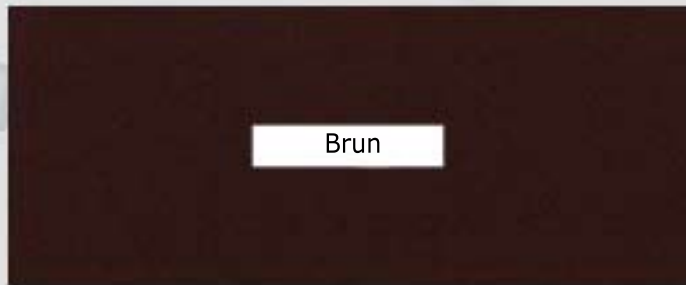

Brun



Café

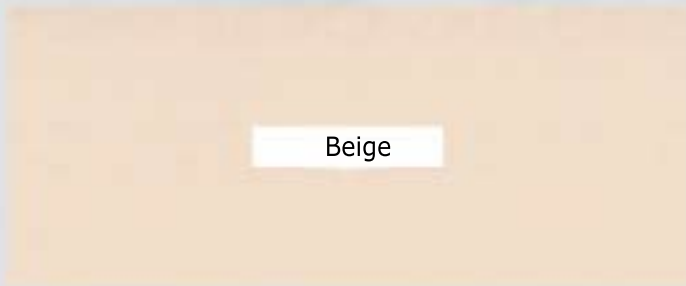

Beige



Bleu Ocean



Turquoise



Rouge



Vert Forêt



Jaune

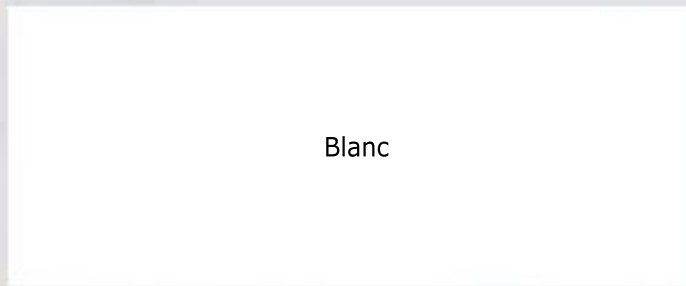

Blanc



Galvanisé



Argent



St. Mark's Episcopal Church  
Venice, FL



Englewood Sports Complex  
Englewood, FL

Nokomis Park  
Nokomis, FL





Land O' Lakes Christian School  
Land O' Lakes, FL



South County Regional Park  
Charlotte County, FL

